

3a

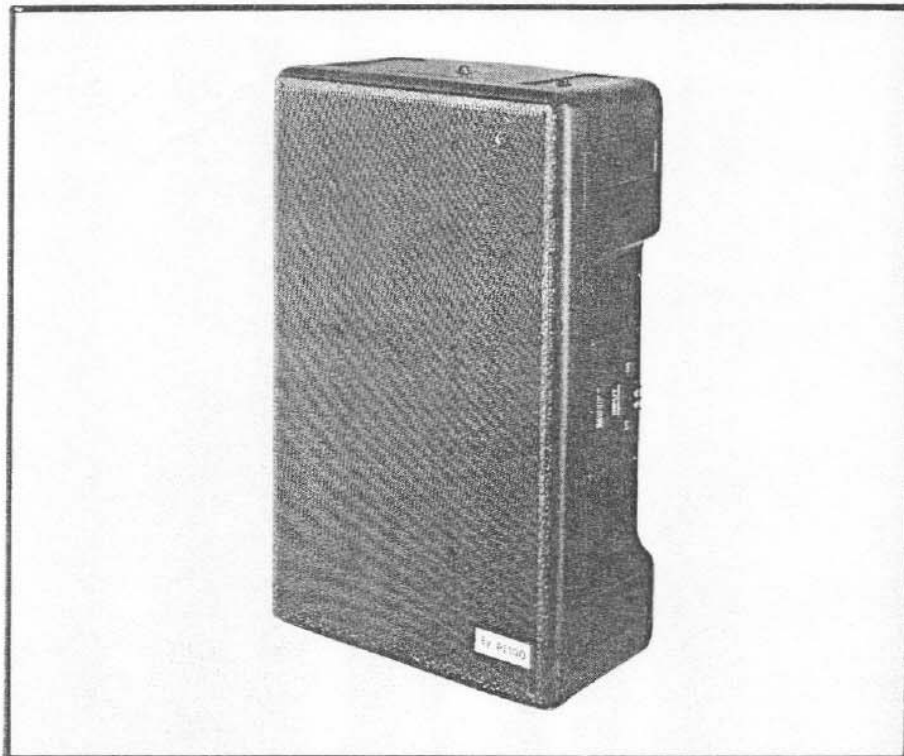

**Electro-Voice®**  
a gulton company

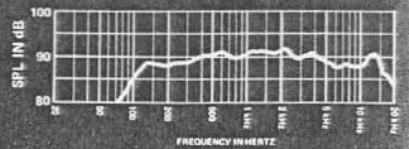

FIGURE 1 — Axial Frequency Response 4 volts/10 feet

## Model PI100

### Two-Way Constant Directivity Speaker System

#### SPECIFICATIONS

Frequency Response, 10 Feet on Axis, Swept-One-Third Octave Pink Noise, Half-Space Anechoic Environment (see Figure 1):  
80—18,000 Hz

Low-Frequency 3-dB-Down Point:  
80 Hz

Usable Low-Frequency Limit (10-dB-Down Point):  
50 Hz

Half-Space Reference Efficiency:  
2.3%

Long-Term Average Power Handling Capacity at 8 Ohms (see Power Handling Capacity section):  
100 watts

Maximum Woofer Acoustic Output:  
2.3 watts

Sound Pressure Level at 1 Meter 1 Watt Input, Anechoic Environment, Band-Limited Pink Noise Signal, 300 to 2,000 Hz:  
96 dB

Dispersion Angle Included by 6-dB-Down Points on Polar Responses, Horizontal and Vertical Planes, Indicated One-Third-Octave Bands of Pink Noise,

250—500 Hz:  
150° ± 30°

500—10,000 Hz:  
100° ± 20°

10,000—20,000 Hz:  
60° ± 12°

Directivity Factor  $R_d$  (Q), 1,800—16,000 Hz Median (see Figure 4):  
10 (+12.5, -4.5)

Directivity Index  $D_i$ , 1,800—16,000 Hz Median (see Figure 4):  
10 dB (+3.5 dB, -2.5 dB)

Phase Variation, 300—3,000 Hz:  
± 30°

Distortion, 0.1 Full Power Input (see Figure 5),

Second Harmonic,  
100 Hz: <1%  
1000 Hz: 4%  
10,000 Hz: 3%

Third Harmonic,  
100 Hz: 1%  
1000 Hz: <1%  
10,000 Hz: <1%

Distortion, 0.01 Full Power Input (see Figure 6),

Second Harmonic,  
100 Hz: <0.5%  
1000 Hz: 1%  
10,000 Hz: 1.5%

Third Harmonic,  
100 Hz: <1%  
1000 Hz: <1%  
10,000 Hz: 1%

Transducer Complement:  
12-inch woofer  
1-1/2 inch Super-Dome™ tweeter  
coupled to 9-inch Direktor™

Box Tuning Frequency:  
48 Hz

Crossover Frequency:  
1,500 Hz

Crossover Slope:  
12 dB per octave

Impedance,  
Nominal:  
8 ohms

Minimum:  
6.5 ohms

Input Connections:  
Screw terminals (#8-32) on barrier strip

Enclosure Material and Finish:  
One-piece, ultraviolet-stabilized medium-density polyethylene with a foamed inner wall and a hard outer wall; metal grille

Color:  
Black; molded in

Weather Resistance (see Description section for details):

Environmentally resistant parts with foam water shield over transducers

Mounting:  
Hanging via eight 1/4-20 threaded inserts or optional WCB-1 wall/ceiling U-bracket

Optional Accessories:  
WCB-1 wall/ceiling U-bracket  
TK60 watt 25 volt/70.7 volt Line-transformer kit

Dimensions:  
61.0 cm (24 in.) high  
38.1 cm (15 in.) wide  
21.6 cm (8.5 in.) deep

Net Weight:  
12.7 kg (28 lb)

Shipping Weight:  
13.6 kg (30 lb)

#### DESCRIPTION

The Electro-Voice PI100 is a compact two-way, constant-directivity speaker system design for both indoor and outdoor sound reinforcement in commercial installations. The PI100 components provide a degree of directivity control and high output that are of a quality normally associated with separate professional components. The depth of the Direktor™ element closely matches the depth of the woofer, providing a strong degree of time-alignment or coherency.

The PI100's ultraviolet-stabilized polyethylene enclosure features a dual-layer sandwich with a hard outer wall layer and a foam cell structure inside. The front of the enclosure is protected by a metal grille lined with ultraviolet-resistant foam which acts as a water shield.

The high-frequency section of the PI100 utilizes a 100° x 100° Direktor coupled to a Super-Dome™ tweeter for the frequency range of 1500 Hz to 18,000 Hz. A unique combination of crossover and equalizer is used with the Super-Dome to give flat response without the need for an external equalizer.

The bass section of the PI100 is designed using Thiele-Small parameters for efficient low-frequency performance extending to frequencies in the 50 to 80 Hz region. The 12-inch woofer used in the system is a specially designed heavy duty unit.

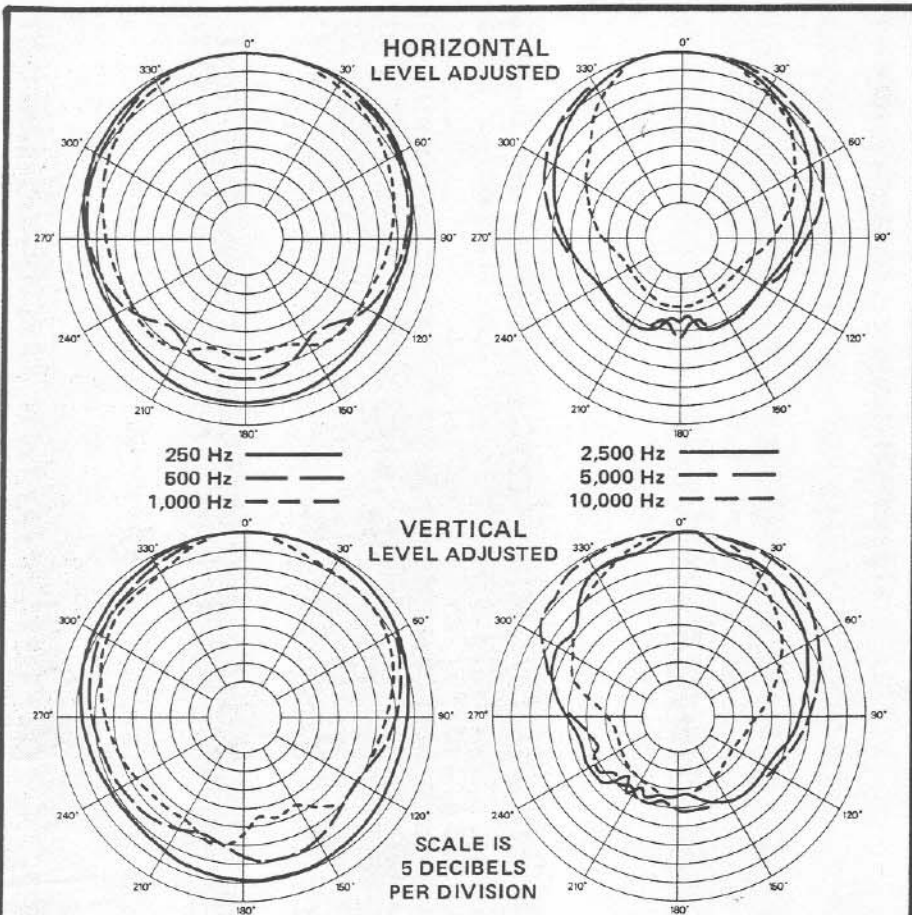

FIGURE 2 — Polar Response (1/3 octave pink noise 4 volts/10 feet)

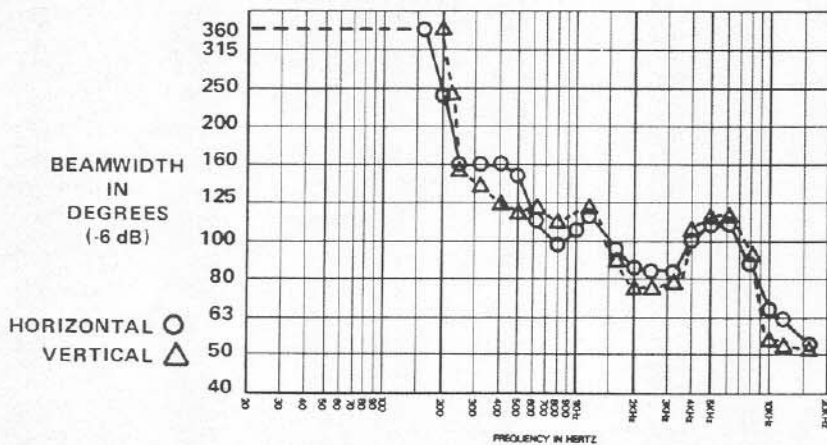

FIGURE 3 — Beamwidth vs Frequency Whole Space (anechoic)

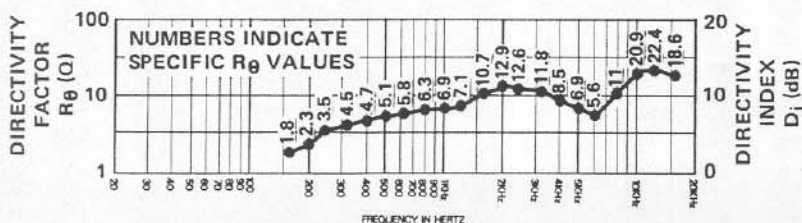

FIGURE 4 — Directivity vs Frequency Whole Space (anechoic)

**Constant-Directivity Speaker System**  
 The crossover frequency and speaker component geometries have been carefully selected so that the directional characteristics of the woofer and Direktor match at the crossover frequency (approximately 100 degrees circular coverage patterns for each) to create a special system type — the constant-directivity system. At higher frequencies the horizontal and vertical coverage pattern remain essentially constant. Response within the 100° x 100° rated coverage angle is uniform, which means dependable audience coverage without "hot spots" or dead zones at certain frequencies. The 100° x 100° dispersion characteristic permits this small system to be used horizontally or vertically to aesthetically best suit the environment it is placed in without basically changing the coverage angles. The controlled directivity of the high- and low-frequency transducers also eliminates response irregularities caused by diffraction off enclosure edges and, in combination with an essentially flat on-axis frequency response, produces a total acoustic power output that is uniform with frequency.

**FREQUENCY RESPONSE**

The combination of a 12-inch woofer, wide-bandwidth, high-frequency Super-Dome tweeter plus Direktor and an equalized crossover results in the wide and smooth overall response shown in Figure 1. This response was measured at 10 feet, using a 4-volt input in an anechoic chamber. The response is 1/3-octave averaged. No external equalization was used.

**DIRECTIVITY**

A unique feature of the PI100 is the constant-directivity dispersion provided by the 100° x 100° Direktor. The polar response of the system at selected 1/3-octave bandwidths is shown in Figure 2. These polar responses were measured in an anechoic environment at 10 feet using 1/3-octave pink noise inputs. The frequencies selected are full representative of the polar response of the system. Beamwidth of the system utilizing the complete 1/3-octave polar data is shown in Figure 3.  $R_{\theta}$  (Q) and directivity index ( $D_i$ ) are plotted in Figure 4.

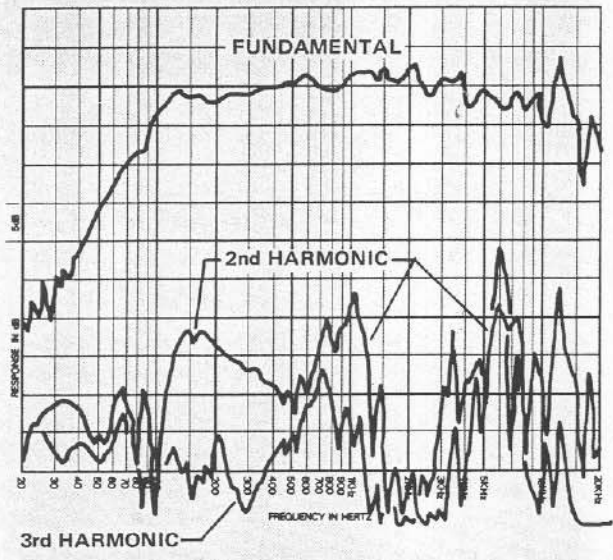

FIGURE 5 — Harmonic Distortion, 0.1 rated power input (10 watts)

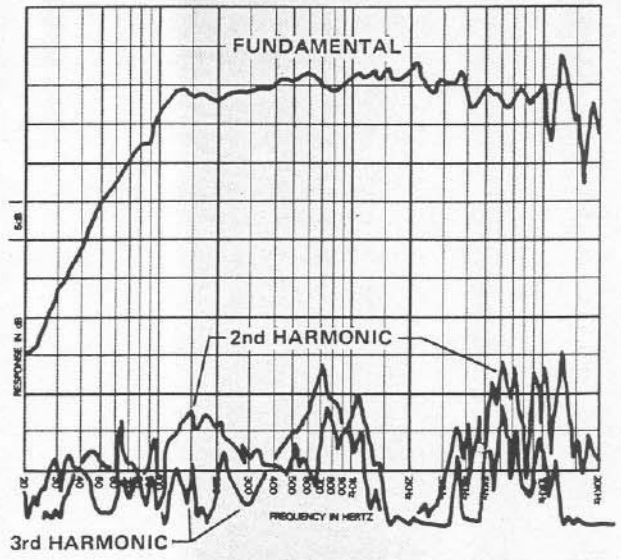

FIGURE 6 — Harmonic Distortion, 0.01 rated power input (1 watt)

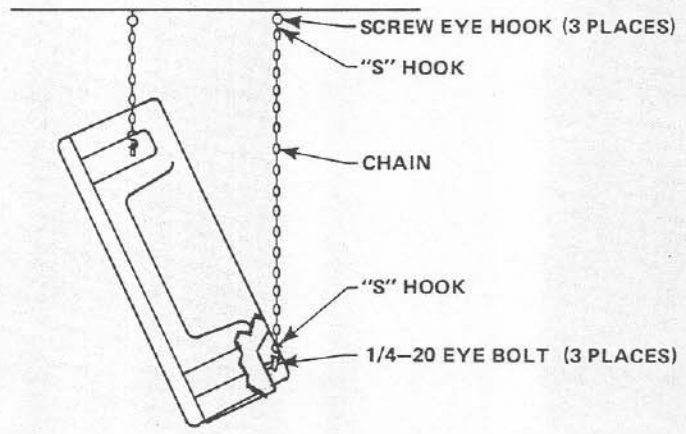
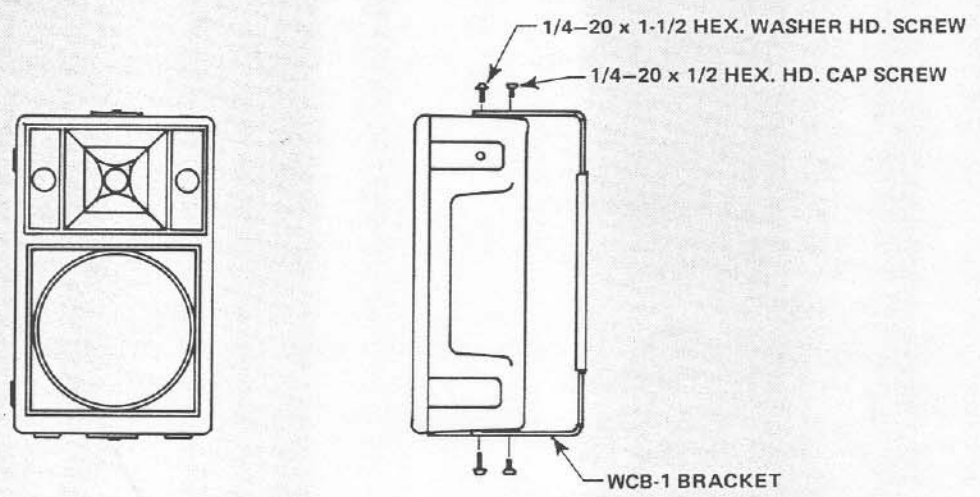

FIGURE 7 — System Mounting



## DISTORTION

Following AES (Audio Engineering Society) recommended practice, plots of second and third harmonic distortion for 0.1 rated power (10 watts) are shown in Figure 5. Additionally, plots are shown for 0.01 rated power in Figure 6. In the important mid-band frequencies between 300 and 3000 Hz where voice and music energy is usually the highest, the median values for any component of distortion are at or below approximately 1% for the input powers measured.

## POWER HANDLING CAPACITY

To our knowledge, Electro-Voice was the first U.S. manufacturer to develop and publish a power test closely related to real-life conditions. First, we use a random noise input signal because it contains many frequencies simultaneously, just like real voice or instrument program. Second, our signal contains more energy at extremely high and low frequencies than typical actual program, adding an extra measure of reliability. Third, the test signal includes not only the overall "long-term average" or "continuous" level — which our ears interpret as loudness — but also short-duration peaks which are many times higher than the average, just like actual program. The long-term average level stresses the speaker thermally (heat). The instantaneous peaks test mechanical reliability (cone and diaphragm excursion). Note that the sine wave test signals sometimes used have a much less demanding peak value relative to their average level. In actual use, long-term average levels exist from several seconds on up, but we apply the long-term average for several hours, adding another extra measure of reliability.

Specifically, the PI100 is designed to withstand the power test described in the revised EIA Standard RS-426A. The EIA test spectrum is applied for eight hours. To obtain the spectrum, the

output of a white noise generator (white noise is a particular type of random noise with equal energy per bandwidth in Hz) is fed to a shaping filter with 6-dB-per octave slopes below 40 Hz and above 318 Hz. When measured with the usual constant-percentage bandwidth analyzer (one-third octave), this shaping filter produces a spectrum whose 3-dB-down points are at 100 Hz and 1200 Hz with a 3-dB-per octave slope above 1200 Hz. This shaped signal is sent to the power amplifier with the continuous power set at 100 watts into the 6 ohms EIA equivalent impedance, (24.5 volts true RMS). Amplifier clipping sets instantaneous peaks at 6 dB above the continuous power, or 400 watts peak (49 volts peak). This procedure provides a rigorous test of both thermal and mechanical failure modes.

## MOUNTING

The cabinet is supplied with threaded inserts which will allow horizontal or vertical mounting with chains. (Note that the nameplate rotates for proper orientation in any mounting position.) The user must supply eyelet bolts, "S" hooks and chains.

An optional U-bracket is available, the WCB-1 wall/ceiling mounting bracket. The WCB-1 may be affixed between the ends (i.e. the 61 cm or 24-inch dimension) of the PI100 and allows a great degree of angular adjustment of the system.

Figure 7 illustrates a ceiling mount using eyebolts and chains, and a wall mount using the WCB-1 bracket.

## LINE-TRANSFORMER KIT

The TK60 (25/70.7 volt) line-transformer kit is an option available for high-impedance systems, generally desired in multi-speaker distributed designs and some smaller systems where long speaker-wire runs are necessary.

An Electro-Voice TM60 transformer is mounted on an input panel that is substituted for the direct (8 ohms) input panel supplied with the system. The TK60 allows direct input to the system or access to any of the seven transformer taps covering 7.5, 15, 30, and 60 watts at 25 and 70.7 volts. Connections are made on barrier strips with # 8-32 screws.

## WARRANTY (Limited) —

Electro-Voice Professional Sound Reinforcement Loudspeakers and Accessories are guaranteed for five years from date of original purchase against malfunction due to defects in workmanship and materials. If such malfunction occurs, unit will be repaired or replaced (at our option) without charge for materials or labor if delivered prepaid to the proper Electro-Voice service facility. Unit will be returned prepaid. Warranty does not cover finish or appearance items or malfunction due to abuse or operation at other than specified conditions. Repair by other than Electro-Voice or its authorized service agencies will void this guarantee.

For shipping address and instructions on return of Electro-Voice products for repair and locations of authorized service agencies, please write: Service Department, Electro-Voice, Inc., 600 Cecil Street, Buchanan, Michigan 49107 (Phone: 616/695-6831) or Electro-Voice West, 8234 Doe Avenue, Visalia, California 93277 (Phone: 209/651-7777).

Electro-Voice also maintains complete facilities for non-warranty service.

Service and repair address for this product: Electro-Voice, Inc., 600 Cecil St., Buchanan, Michigan 49107.

Specifications subject to change without notice.